

CHAPTER 2

QUANTITY TAKE-OFF

The quantity “takeoff” is an important part of the cost estimate. It must be as accurate as possible and should be based on all available engineering and design data. Use of appropriate automation tools is highly recommended. Accuracy and completeness are critical factors in all cost estimates. An accurate and complete estimate establishes accountability and credibility of the cost engineer, therefore, providing greater confidence in the cost estimate. The estimate contingencies for programming purposes reflect the estimate confidence.

2.1 Importance of Quantity Takeoff and Required Documents

The quantity of material in a project can be accurately determined from the drawings. The estimator must review each sheet of the drawings, calculate the quantity of material and record the amount and unit of measure. Each estimator must develop a system of quantity takeoff that ensures that a quantity is not omitted or calculated twice. A well-organized check-list of work will help reduce the chances of omitting an item. The estimator must, also, add an appropriate percentage for waste for those items where waste is likely to occur during construction. The material quantity takeoff is extremely important for cost estimating because it often establishes the quantity and unit of measure for the costs of labor and contractor’s equipment.

2.1.1 Contract documents

The contract is defined by the contract documents, which are developed from the tender documents. In a logical order, these documents refer to the following subjects:

- Input from the client (task description).
- Output of the contract (specifications, results to be achieved).
- Prices for the contractor's contribution.
- Responsibilities and procedures (liability, resources provided, time schedule, payment conditions, changes procedures, etc).

Contract documents are usually arranged according to the following sequence:

- General (for any project).
- Special (for a specialty area of the project).
- Supplementary (unique to a given project).
- Additional (during bidding or negotiation).
- Agreement form (for signing very important and particular clauses).
- Modifications (during contract fulfillment).

The complete contract agreement usually consists of the following documents:

- Conditions (general, special, supplementary).
- Drawing and specifications.
- Addenda.
- Agreement form.
- Modifications.

The most important document from the legal point of view is the agreement. It is sometimes called the contract. Since so many documents are included as contract documents, the agreement is the better term for this particular one. The form of the agreement can be standardized and used for many projects, or a unique document can be prepared for each project. The standard form of agreement prescribed by the American Institute of Architects has proved to be satisfactory and has been used on many building projects with good results. The form followed for non-building projects is often more varied. Many agencies have own standard forms, which are used on all their projects.

Information usually included in the agreement of three parts. The first part is a short introductory paragraph which defines the parties, gives the date of the agreement, and state that each party agrees to what follows. The second part contains the elements of contract and defines the work to be undertaken. The final paragraph confirms the agreement and provides space for signatures of the parties. Thus, the agreement usually composed of the following articles:

1. A short introductory paragraph.
2. Scope of the work.
3. Time of completion.
4. Contract documents.
5. Performance bond.
6. Contractor's insurance.
7. Owner's insurance.
8. Laws, regulations and permits.
9. Payments.
10. Extensions of time.
11. Changes in the work.
12. Owner's right to terminate the work.
13. Contractor's right to terminate the work.
14. Confirmation and signatures.

2.1.2 *Quantity take-off: Why?*

Owner perspective:

- Initial (preliminary) estimate of the project costs at the different stages of the project.
- Preparing the BOQ as a requirement of the contract documents.
- Estimating the work done for issuing the contractor payments.

Contractor perspective:

- Pricing different work items.
- Identifying the needed resources (Labor, Equipment, etc.).
- Project schedule.
- Preparing invoices for work done.
- Subcontractors' payments.
- Review and control of crews' production rates.

2.2 Quantity Development

After the scope has been analyzed and broken down into construction tasks, each task must be quantified prior to pricing. Equal emphasis should be placed on both accurate quantity calculation and accurate pricing. Quantities should be shown in standard units of measure and should be consistent with design units. Assistance for preparing “takeoffs” may be provided by others within the organization in support of cost engineering; however, the responsibility for the accuracy of the quantities remains with the cost engineer. Distinction should be made between “net” quantities without waste versus quantities that include waste or loss. This is necessary to ensure duplication does not occur within the estimate.

The detail to which the quantities are prepared for each task is dependent on the level of design detail. Quantity calculations beyond design details are often necessary to determine a reasonable price to complete the overall scope of work for the cost estimate. A simple example would be fabrication waste material that is a material cost to the project. Project notes will be added at the appropriate level in the estimate to explain the basis for the quantity calculations, to clearly show assumed quantity allowances or quantity contingencies, and to record quantities determined by cost engineering judgment that will be reconciled upon design refinement. Use the following recommended guidelines in quantity development:

- Coordinate the quantity takeoff process and plan with the estimator.
- Ensure full project scope is reflected within the estimate.
- Include a list of materials in quantity takeoffs.

- Utilize a process that easily records the quantity development, i.e., document source and date, estimator name and date, location within the project, demonstrated calculations and additions such as waste or loss.
- Use a systematic approach similar to the construction methodology required.
- Check scales and dimensions on each drawing sheet.
- Highlight or mark drawing areas where quantities have been determined to ensure all scope is captured but not double counted.
- Consider items that have no material but still require cost, e.g., job office overhead (JOOH), task setup, training and certifications, and labor preparation.
- Develop quantities within a reasonable range for the work using decimals where critical.
- Add a certain amount of waste, loss, drop off, or length related to the material purchases for a bulk order. Ensure this addition is separate from the original quantity measured.
- Select a natural stopping point during work interruptions.
- Coordinate with designers if the design appears in error, if a better approach is discovered, or a value engineering process is warranted.

2.3 Bill of Quantities

The Bill of Quantities (BOQ) is defined as a list of brief descriptions and estimated quantities. The quantities are defined as estimated because they are subject to admeasurement and are not expected to be totally accurate due to the unknown factors which occur in civil engineering work. The objective of preparing the Bill of Quantities is to assist estimators to produce an accurate tender efficiently and to assist the post-contract administration to be carried out in an efficient and cost-effective manner. It should be noted that the quality of the drawings plays a major part in achieving these aims by enabling the taker-off to produce an accurate bill and also by allowing the estimator to make sound engineering judgments on methods of working. Figure 2.1 shows a sample of a bill of quantities.

Number	Item description	Unit	Quantity	Rate	Amount	

Item No.	Description	Unit	Qty	Unit Price		Total Price	
				(L.E)	(US\$)	(L.E)	(US\$)
Section (03) - Earth Work							
	Reference shall be made to section (3) of specifications .						
3.01	Excavation in any type of soil (except rock) including scaffoldings , dewatering of ground and surface water and transportation of water either to sewerage networks or open drains during the whole foundation construction period (till completion of filling) , shoring or sheet piling of excavation sides , transportation of excavated material to dump areas approved by the organization and compensation for excavation outside the geometric measured volumes .						
	rate per cubic metre						
	From existing level (± 0.00 to (-2.00 ms)	M ³	1000			0	
	For parts deeper than (-2.00) To (-4.00 ms)	M ³	50			0	
	For parts deeper than (-4.00) To (-6.00 ms)	M ³	0			0	
3.02	As previous item (3.01) , but for manual excavation for exploratory pits including filling of these pits .						
	rate per cubic metre						
	From existing level (± 0.00 to (-2.00 ms)	M ³	10			0	
	For parts deeper than (-2.00) To (-4.00 ms)	M ³	10			0	

Fig. 2.1: Bill of quantities sample

The bill of quantities, when completed, is traditionally presented in trade format; that is, in a given order, for example:

- Demolition and alteration
- Groundwork
- Concrete work
- Masonry
- Etc.

Also, the bill of quantities is classified into the following work groups:

- Civil works which includes: Earth works (leveling, excavation, backfilling, transportation of excavated soil); Foundation works (plain and reinforced concrete, piling foundations); Brick works (internal and external); Skelton reinforce concrete (columns, beams, slabs and stairs); Water proofing; Staircases; Plastering, Flooring; Painting; Metal works (windows, doors, accessories); etc.
- Sanitary works which includes: Water feeding systems; Internal and external plumbing works; Finishes of plumbing works; etc.
- Electrical works which includes: Electrical cables; Wiring; Accessories; Internal connections; etc.
- Mechanical works which includes: Air conditioning systems; Elevators; etc.

2.4 Measurement Practice

It is vitally important that measurement practice applied to buildings is both accurate and consistent. There are a number of situations that require a quantity surveyor to measure and record dimensions from both drawings as well as on site, depending on the stage of the project. In order to standardize measurement rules and conventions, there are a number of standard codes and methods of measurement that are available. These are outlined below.

There are various approaches to measurement for bills of quantities and these are as follows:

- *Each (numbers)*: Piles, doors, Windows, Precast concrete, etc.
- *Length (meter)*: Windows sills, Pipes, Skirts, stair steps, etc.

- *Area (Square meter)*: Flooring, painting, plastering, Brick walls (12 cm or less), etc.
- *Volume (Cubic meter)*: Brick walls (>12 cm thick), Excavation, Backfilling, Reinforced Concrete, etc.
- *Weight (Ton)*: Metallic works, Reinforcement steel, etc.
- *Lump Sum*: Some electrical and plumbing works, Manholes, etc.
- *Effort (Man-day)*: Renting of equipment or labor, etc.

Figure 2.2 shows a sample of the quantity surveying table for quantity take-off.

اسم الوزارة أو الهيئة العامة أو الشركة

عملية

شكل نموذج قائمة الكميات

ملاحظات	إجمالي	متر مكعب		متر مربع			عدد	الوحدة	نوع الأعمال والتوريدات	رقم
		إزالة	إضافة	ارتجاع	مرشح	كابل				

ممثل المفاضل

المراجع الحسابي

مهندس المالك

المهندس المراجع

Quantity Surveying Table

Fig. 2.2: Quantity take-off table

2.4.1 Earth works

Earth works comprises site level, excavation, backfilling and transportation of excavated materials.

Excavation:

- Quantities are calculated based on the dimensions of the foundation in plans from the owner perspective.
- Contractors should consider the excess of material excavated to all for safe operations.
- Prices differ based on the soil type, deep of excavation, ground water level, site location, shoring system, Equipment used, etc.
- Unit of measurement is cubic meter (volume).
- Consider the following example (Figure 2.3).

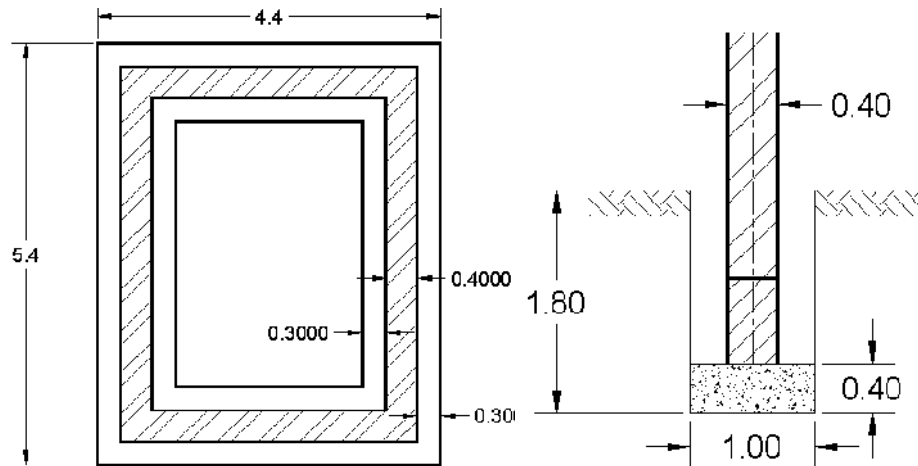

Fig. 2.3: Plan and cross section of building foundation

The length of excavation = $5.4 \times 2 + (4.4 - 2) \times 2 = 15.6$ m

Depth of excavation = 1.8 m

Width of excavation = width of plain concrete footing = 1.0 m

Volume = $15.6 \times 1.8 \times 1.0 = 18.8$ m³

- Consider another example (Figure 2.4). Plain concrete dimensions (1.2 × 2.0 × 0.2 m), reinforced concrete footings dimensions (0.8 × 1.6 × 0.4 m); depth of excavation 1.2 m and ground beams cross section is (0.25 × 0.4 m). Find the

volume of the excavated material (see Figure 2.4). Distance between centerlines is 5 m.

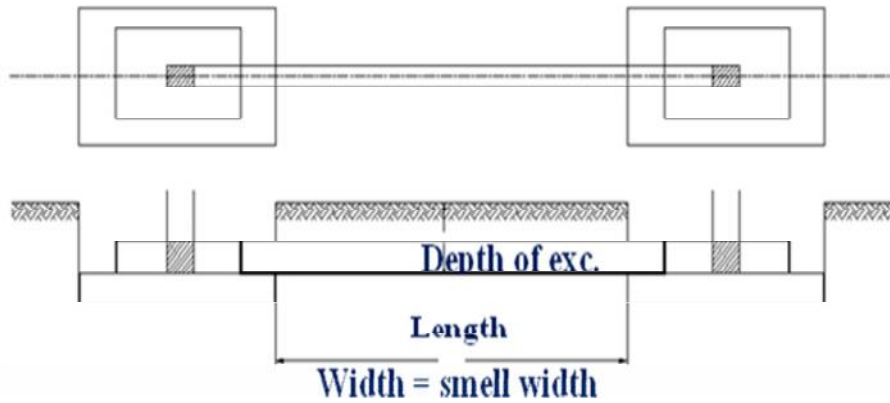

Fig. 2.4: Footing foundation plan and cross section

$$\text{Excavation for footings} = 2 \times 1.2 \times 2.0 \times 1.2 = 5.76 \text{ m}^3$$

$$\text{Excavation for smell} = (5 - 2 \times 1) \times 0.6 \times 0.25 = 0.45 \text{ m}^3$$

$$\text{Volume} = 5.76 + 0.45 = 6.21 \text{ m}^3$$

Backfilling:

- Unit of measurement is cubic meter (volume)
- Backfilling = Excavation – volume of all works inside the excavated pit (footings, smells, column necks, brickwork, etc.) + amount above GL (or – amount below GL) as shown in Figure 2.5.

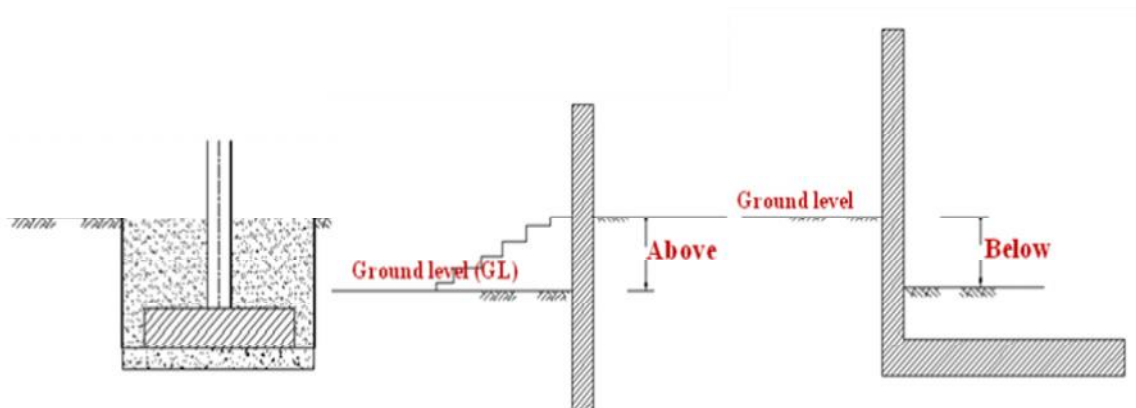

Fig. 2.5: Backfilling quantities calculations

- Consider the example shown in Figure 2.4, the volume of backfilling could be calculated as follow:

Volume of backfilling = excavation – concrete – brick

Volume of concrete = $15.6 \times 1 \times 0.4 = 6.24 \text{ m}^3$

Volume of brick = $15.6 \times 0.4 \times 1.4 = 8.736 \text{ m}^3$

Volume of backfilling = $18.8 - (6.24 + 8.736) = 3.824 \text{ m}^3$

Site leveling:

- Measured in m^2 (area) if thickness less than 30 cm.
- Measured in m^3 (volume) if thickness more than 30 cm.

Soil transportation:

- Transported soil = vol. of exc. – vol. of backfilling + additional soil at site
- Add swelling factor based on the soil type: 5% sandy soil. 15% clayey soil and 25% for demolition material. (owner or contractor)

2.4.2 Concrete works:

Concrete works comprises of both plain concrete (PC) and reinforced concrete (RC).

Plain concrete (PC):

- Measured in m^2 (area) if thickness < 20 cm.
- Measured in m^3 (volume) if thickness ≥ 20 cm.
- Average thickness should be mentioned when measurement is done by area.

Reinforced concrete (RC):

- All RC elements measured by volume (m^3) except hollow block slabs measured by area (m^2).
- Domes, cylindrical roofs and shells measured by area in the horizontal projection.

2.4.3 Brick works:

The rules and precautions that should be followed when measuring brick works are (Figure 2.6):

- Measured in m^2 (by area) if thickness <25 cm.
- Measured m^3 (by volume) if thickness ≥ 25 cm.
- Deduct all openings.
- Deduct half the area (volume) of arches.
- Deduct all Concrete elements.
- Facades are measured by area.
- Separate item for each brick type

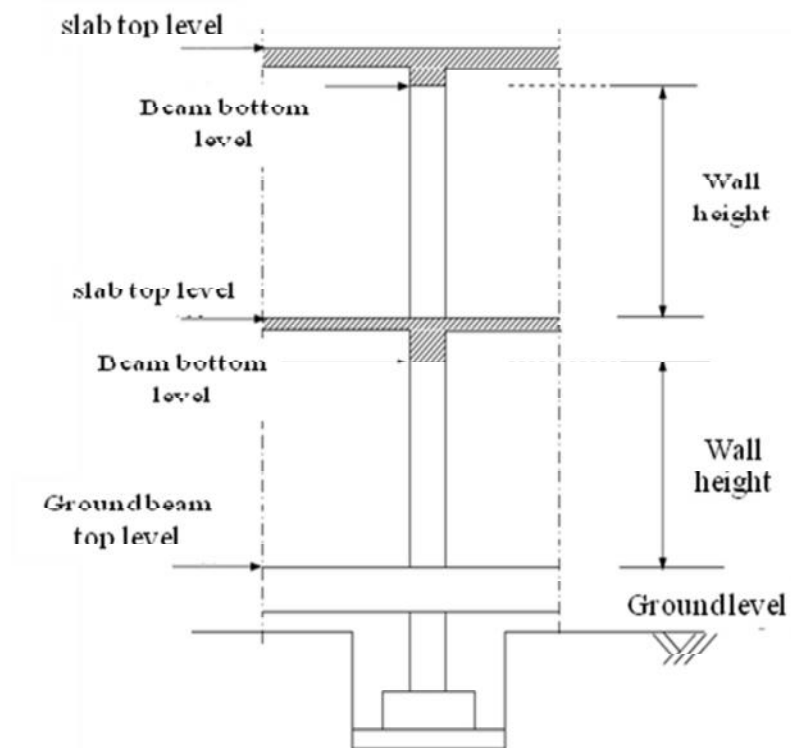

Fig. 2.6: Cross section of brick walls

2.4.4 Plastering:

Plaster works are measured according to its location of being internal or external works. Internal plaster work measured as it is (engineering measurement).

Internal Plaster:

- Engineering measurement by area (m²).
- All openings are deducted.
- All openings sides are added.
- Inclined slabs are calculated based on their horizontal projection.

External plaster:

- Measured by area (m²).
- Openings with areas < 4 m² are kept with deduction.
- Deduct half the area of the openings ≥ 4 m².
- Openings with areas < 4 m² are kept with deduction.
- Cantilever slabs < 1 m projection not added.
- Add half the area of cantilever slabs ≥ 1 m.

2.5 Example Application: Substructure

As with most measurement exercises it is good practice to start with a taking-off list containing all the items that have to be included on a Substructure – taking-off list:

- Site preparation Removing trees and shrubs
 Lifting turf
 Top soil/removing/preserving
- Excavation Reduce levels/disposal of excavated material
 Excavating trenches/disposal of excavated material
 /filling/surface treatments
- Earthwork support to sides of reduced level/sides of trenches
- Concrete Foundations
 Beds/formwork/damp-proof membrane
- Masonry Brick walls/facings
 Forming cavities
 Filling to cavities
 Damp-proof courses

Site levels

Virgin sites will almost certainly be covered with a layer of vegetation that has to be removed prior to excavation and stored separately or removed from site. Top soil cannot be used for backfilling as it would, over time, cause damage to the substructure. The usual default depth for topsoil is 150 mm although it could be more than this and a test pit may be dug to accurately determine the actual depth. Figure 2.7 shows a 5 m grid of a survey of levels taken on a proposed site.

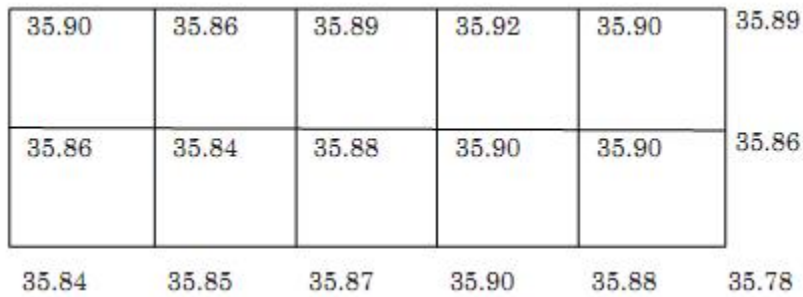

Fig. 2.7: Grid survey of the proposed site

The site is required to be reduced to a level of 35.62 and in order to calculate the volume of excavation required the average level of the site must be determined. This can be quite easily done by calculating the average level:

$$\text{Average site level} = (35.90 \times 5 + 35.86 \times 3 + 35.89 \times 2 + 35.92 + 35.84 \times 2 + 35.88 \times 2 + 35.85 + 35.87 \times 2) / 18 = 35.87 \text{ m}$$

$$\text{Reduced site level} = 35.62 \text{ m}$$

$$\text{Average excavation depth} = 0.25 \text{ m}$$

$$\text{Total excavation volume} = 0.25 \times 25 \times 10 = 62.5 \text{ m}^3$$

Figure 2.7 shows the ground floor plan of the building with the external and internal walls.

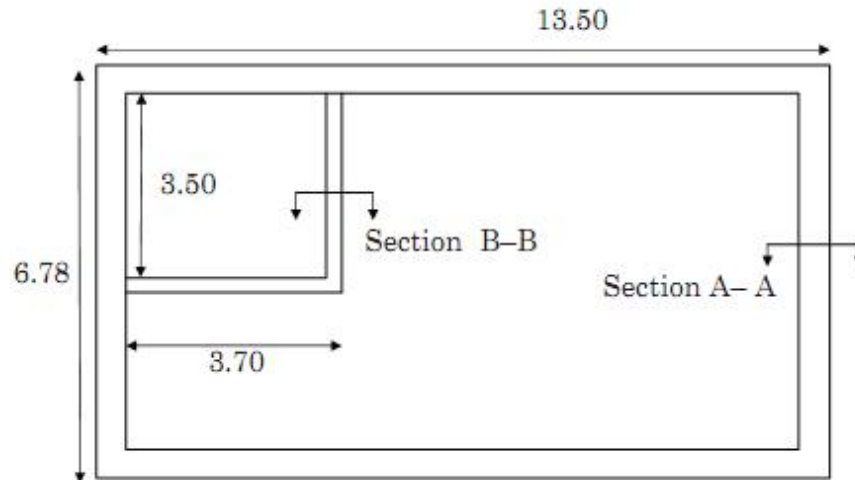

Fig. 2.7: Ground floor plan showing external and internal walls

Figure 2.8 shows a cross-section through the trench and reduced level excavation required for the external wall in the Example application. Note that the levels have been reduced internally by 150 mm to allow for a 150 mm thick bed of hardcore. The top of the hardcore bed when compacted will be covered or blinded with sand to prevent the damp proof membrane, a layer of polythene sheet with a minimum thickness of 0.30 mm, being perforated by the hardcore. It is important that the material used as hardcore is inert and free from chemicals, vegetable or other deleterious matter. It is a requirement of the Building Regulations that insulation is incorporated into the floor construction and in this case 50 mm thick rigid insulation board has been used. The bottom of the trench excavation when completed will be compacted prior to the concrete being poured, this is to prevent the soil being incorporated into the concrete and weakening the mix. This is particularly important when reinforced concrete is being used, where it is common to blind the bottom of the excavation with a weak mix concrete before the reinforcement is placed in position.

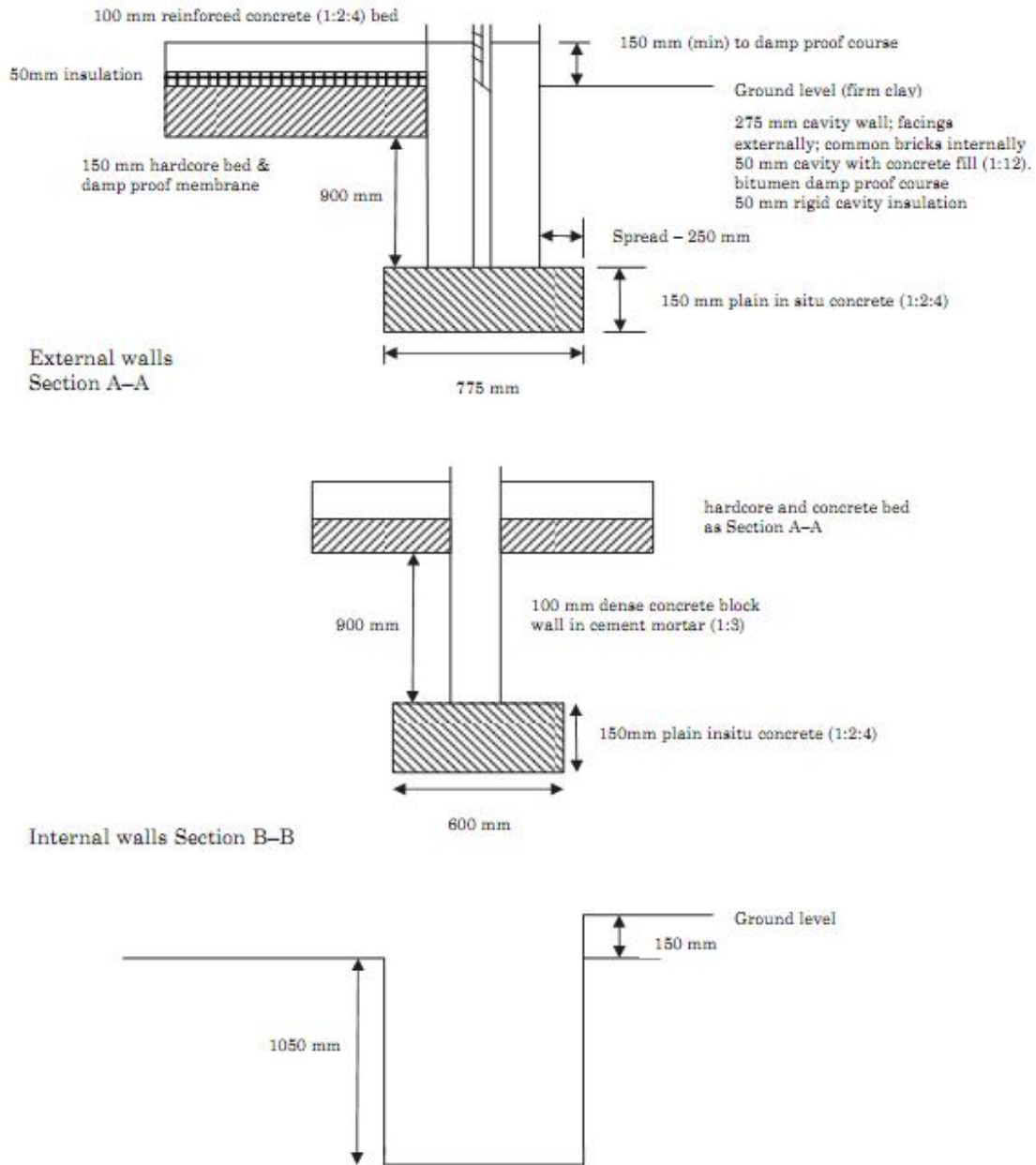

Fig. 2.8: Cross sections of external and internal walls

Working space

Working space is to be measured in circumstances where workmen have to operate in situations that require them to work in trenches below ground level, for example when working with formwork, rendering, tanking or protection. It is measurable as a superficial item where there is less than 600 mm between the face of the excavation and the work; all additional earthwork support, disposal, backfilling and breaking out are deemed to be

included with the working space item. This is another contractor's risk item as he must decide and price what space he thinks is required as illustrated in [Figure 2.9](#).

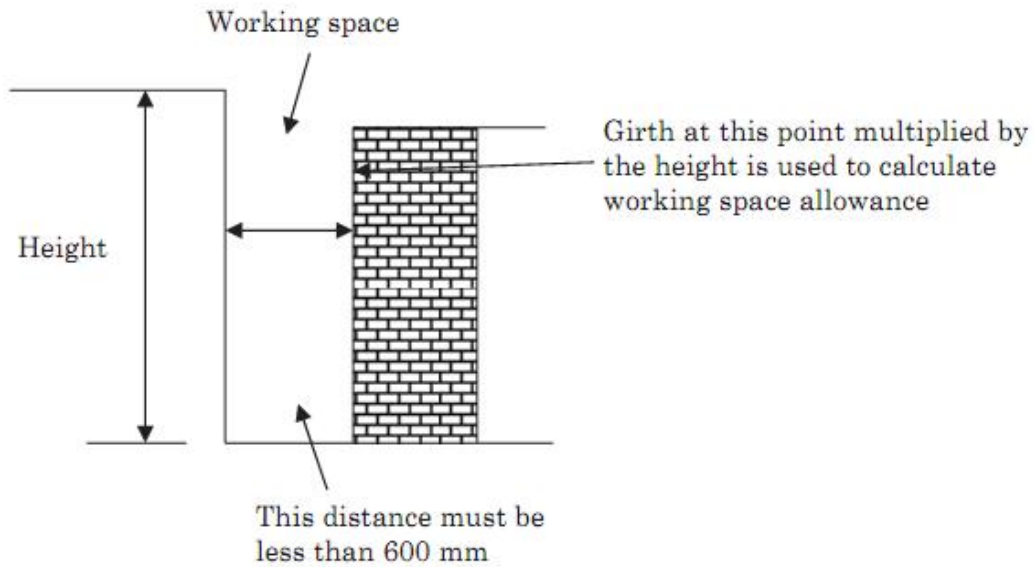

Fig. 2.9: Work space allowance

The different quantities take-off is shown as presented below.

			<u>Oversite excavation</u>	
			13.500	
			<u>Add spread</u>	
			2/0.250 0.500	
			LENGTH <u>14.000</u>	
			Width 6.780	
			<u>Add spread</u>	
			2/0.250 <u>0.500</u>	
			WIDTH <u>7.280</u>	
	14.00	Excavating to reduce levels		
	7.28	maximum depth not exceeding		
	<u>0.15</u>	0.25 m		
		&		
		Disposal of excavated material off site		
		<u>Mean girth</u>		
		Length 13.500		
		Width <u>6.780</u>		
		2/20.280		
		40.560		
		<u>Ddt 4/2/1/0.275 1.100</u>		
		Mean girth <u>39.460</u>		
		<u>Internal partition</u>		
		3.500		
		<u>3.700</u>		
		7.200		
		<u>Ddt</u>		
		Spread to external walls		
		2/0.250 <u>0.500</u>		
		<u>6.700</u>		
	89.46	Excavating trenches width over 0.30m		
	0.78	&		
	<u>1.05</u>			
	6.70			
	0.60	Filling to excavations average		
	<u>1.05</u>	thickness exceeding 0.25 m		
	14.00	Surface treatments compacting		
	<u>7.28</u>	bottoms of excavations		
		1		

The mean girth has been calculated from the outside face of the external wall. To determine the mean girth deduct four times the thickness of the external wall.

If the starting level of the trench excavation is over 250mm below the existing ground level, then this must be stated in the description, SMM7 D20.1.

At this point it is assumed that all of the trench will be backfilled. When concrete and brickwork are measured later the quantities of filling will be adjusted.

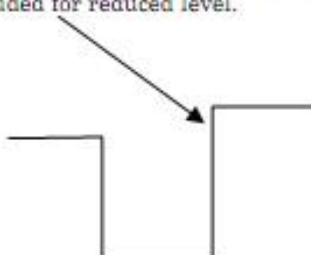
2/	39.46 <u>1.05</u> 42.56 <u>0.15</u>	<p>Earthwork support maximum depth not exceeding 1.00 m and distance between opposing faces not exceeding 2.00 m</p> <p>Intl partition Earthwork support to RL</p> <table style="margin-left: 20px;"> <tr><td>14.000</td></tr> <tr><td><u>7.280</u></td></tr> <tr><td>2/21.280</td></tr> <tr><td><u>42.560</u></td></tr> </table>	14.000	<u>7.280</u>	2/21.280	<u>42.560</u>	<p>The centre line can be used to measure the earth work support, but an additional length must be included for reduced level.</p>  <p>Earthwork support has also been included to the trench for the internal partition.</p> <p>Now that the concrete has been measured the filling can be adjusted together with the disposal of excavated material.</p>							
14.000														
<u>7.280</u>														
2/21.280														
<u>42.560</u>														
2/	6.70 <u>1.05</u>													
	39.46 0.78 <u>0.15</u> 6.70 0.60 <u>0.15</u>	<p>In situ concrete (1:2:4) foundations thickness not exceeding 150 mm poured against earth.</p> <p style="text-align: center;">&</p> <p><u>Ddt</u> Filling to excavation avg thickness exc 0.25 m ab</p> <p style="text-align: center;">&</p> <p><u>Add</u> Disposal of excavated mats ab</p> <table style="margin-left: 20px;"> <tr><td colspan="2">Brickwork</td></tr> <tr><td>Foundations</td><td>0.900</td></tr> <tr><td>Hardcore</td><td>0.150</td></tr> <tr><td>Insulation</td><td>0.050</td></tr> <tr><td>Concrete bed</td><td><u>0.100</u></td></tr> <tr><td>Height</td><td><u>1.200</u></td></tr> </table>	Brickwork		Foundations	0.900	Hardcore	0.150	Insulation	0.050	Concrete bed	<u>0.100</u>	Height	<u>1.200</u>
Brickwork														
Foundations	0.900													
Hardcore	0.150													
Insulation	0.050													
Concrete bed	<u>0.100</u>													
Height	<u>1.200</u>													
2/	39.46 <u>1.20</u>	<p>Walls half brick thick in common bricks laid stretcher bond in cement mortar (1:3)</p> <p style="text-align: center;"><u>Internal partitions</u></p>												
	7.20 <u>1.20</u>	<p>Walls in dense concrete blocks 100 mm thick in cement mortar (1:3)</p> <p style="text-align: center;">2</p>												

	39.46 <u>1.20</u>	Forming cavities in hollow walls 50 mm wide with and including stainless steel twisted wire wall ties @ 5 per square metre.	Wall ties are generally spaced at 900 mm horizontal and 450 mm vertically for cavities between 50 and 75 mm wide
	39.46 0.08 <u>1.15</u>	In situ concrete (1:12) filling to hollow walls not exceeding 150 mm thick.	The cavity filling is slightly less than the item for forming cavities to take account of the splay to the top edge. Note cavity fill should be stopped at least 225 mm below the base of the dpc.
		Adjustment for brickwork in trenches	
	39.46 0.28 <u>0.90</u> 7.20 0.10 <u>0.90</u>	<p><i>Ddt</i> External walls Filling to excavation ab</p> <p style="text-align: center;">& Partitions</p> <p><i>Add</i> Disposal of excavation mats ab</p> <p style="text-align: right;">Girth of external face 40.560 <i>Add</i> 4/2/1/2/0.250 <u>1.000</u> <u>41.560</u></p>	
	41.56 0.25 <u>0.15</u>	<p><i>Ddt</i> Disposal of excavated mats ab</p> <p style="text-align: center;">&</p> <p><i>Add</i> Filling to excavation ab</p>	<p>Adjustment for reduced level excavation</p>
2/	39.46 <u>0.11</u> 7.20 <u>0.10</u>	Horizontal dense polythene damp-proof courses not exceeding 225 mm wide lapped 150 mm at joints and bedded in gauge mortar (1:1:6)	Damp-proof courses come in variety of materials including bituminous felt, lead cored felt and dense polythene. It is applied to both leaves of a cavity wall and lapped 150 mm at joint in the dpc. It must not bridge or span the cavity.
		3	

			Ground floor	
			13.500	
			<u>Less</u> Extl walls 2/0.275	<u>0.550</u>
				<u>12.950</u>
			6.780	
			<u>Less</u> Extl walls 2/0.275	<u>0.550</u>
				<u>6.230</u>
	12.95 <u>6.23</u>	<p>Reinforced in situ concrete (1:3:6) bed not exceeding 150 mm thick $X 0.10 = \quad m^3$</p> <p style="text-align: center;">&</p> <p>Fabric reinforcement Ref A252 weighing 3.95 kg/m² with 150 mm minimum side and end laps.</p> <p style="text-align: center;">&</p> <p>Imported hardcore filling to make up levels not exceeding 0.25 m thick compacted in layers 150 mm thick $X 0.15 = \quad m^3$</p> <p style="text-align: center;">&</p> <p>Surface treatment compacting filling including blinding with sand</p> <p style="text-align: center;">&</p> <p>1200 gauge polythene horizontal damp-proof membrane exceeding 300 mm wide laid on blinded hardcore to receive insulation</p> <p style="text-align: center;">&</p> <p>50 mm thick horizontal rigid sheet insulation laid on concrete</p>		
	7.20 <u>0.10</u>	<p><u>Dot</u> Internal partition</p> <p>Last 6 items</p> <p style="text-align: center;">4</p>		
				<p>Note: the damp-proof membrane and damp-proof course are lapped on the inner skin of the external wall.</p>

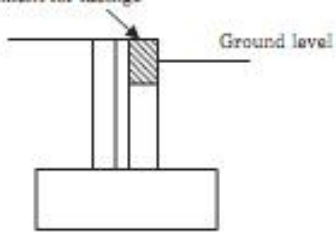
<p>2/ <u>12.95</u> 2/ <u>6.23</u> <u>3.50</u> 2/ <u>3.60</u> 2/ <u>3.70</u></p>	<p>40.11 <u>0.30</u></p>	<p>Damp-proof membrane ad not exceeding 200 mm wide</p> <p><u>Adjustment of facings to external skin</u></p> <p><i>Centre line for external skin</i></p> <p>External face 40.560</p> <p><u>Ddt</u> 4/2/1/2/0.112.5 <u>0.450</u> <u>40.110</u></p> <p>Half brick wall in facings, vertical pointed one side</p> <p>&</p> <p><u>Ddt</u> Half brick wall in common bricks ab.</p> <p>5</p>	<p>Previously, the external wall has been measured with two skins of common bricks. However, the external skin is built in facings, a much more durable and weather resistant brick. Facing bricks also provide a much superior finish. The facings extend 150 mm below the finished ground level</p> <p>Adjustment for facings</p>  <p>The SMM7 requires other items to be included in the substructure such as disposal of surface water, which is included as an item. This is best done at draft bill stage.</p>
---	-------------------------------	--	--

2.6 Exercises

1. Consider the following figure, it is required to prepare a quantity take-off for the following types of work to be included on the bill of quantities:

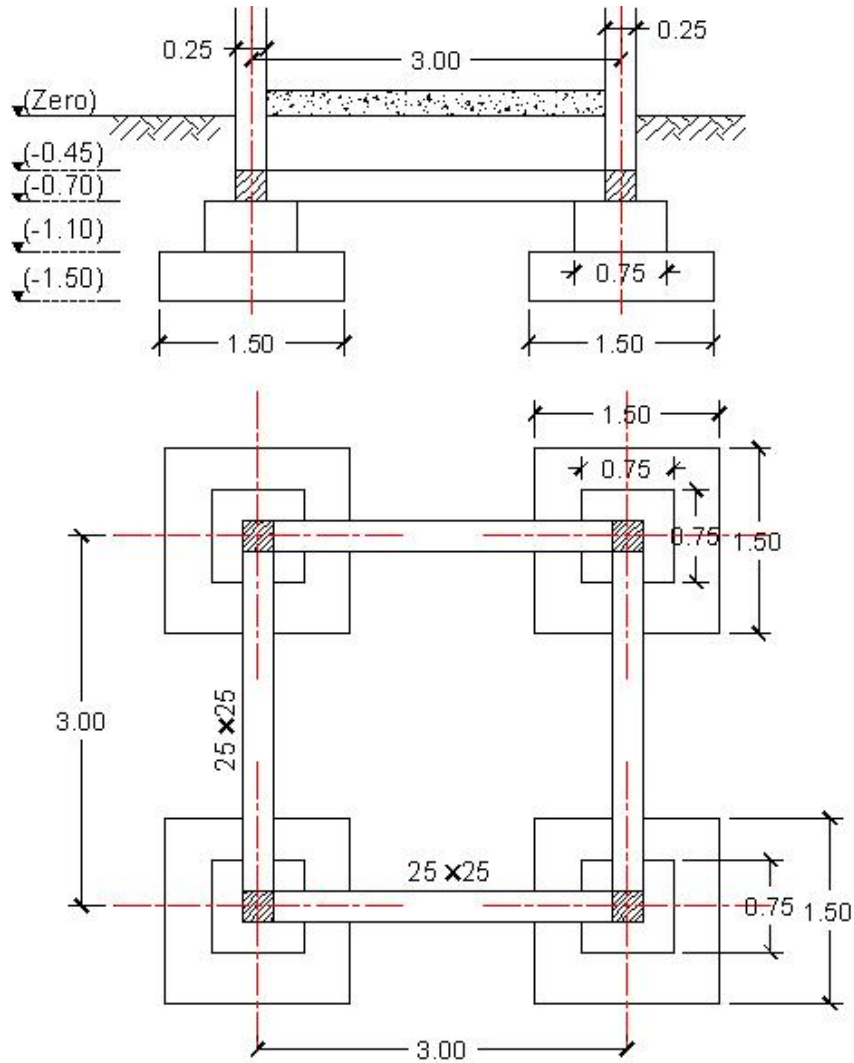

- a. Excavation.
- b. Backfilling
- c. Plain concrete footing
- d. Reinforced concrete footings and columns and column necks till the ground level.
- e. Insulation.

2. Consider the following figure; find the same requirements as above.

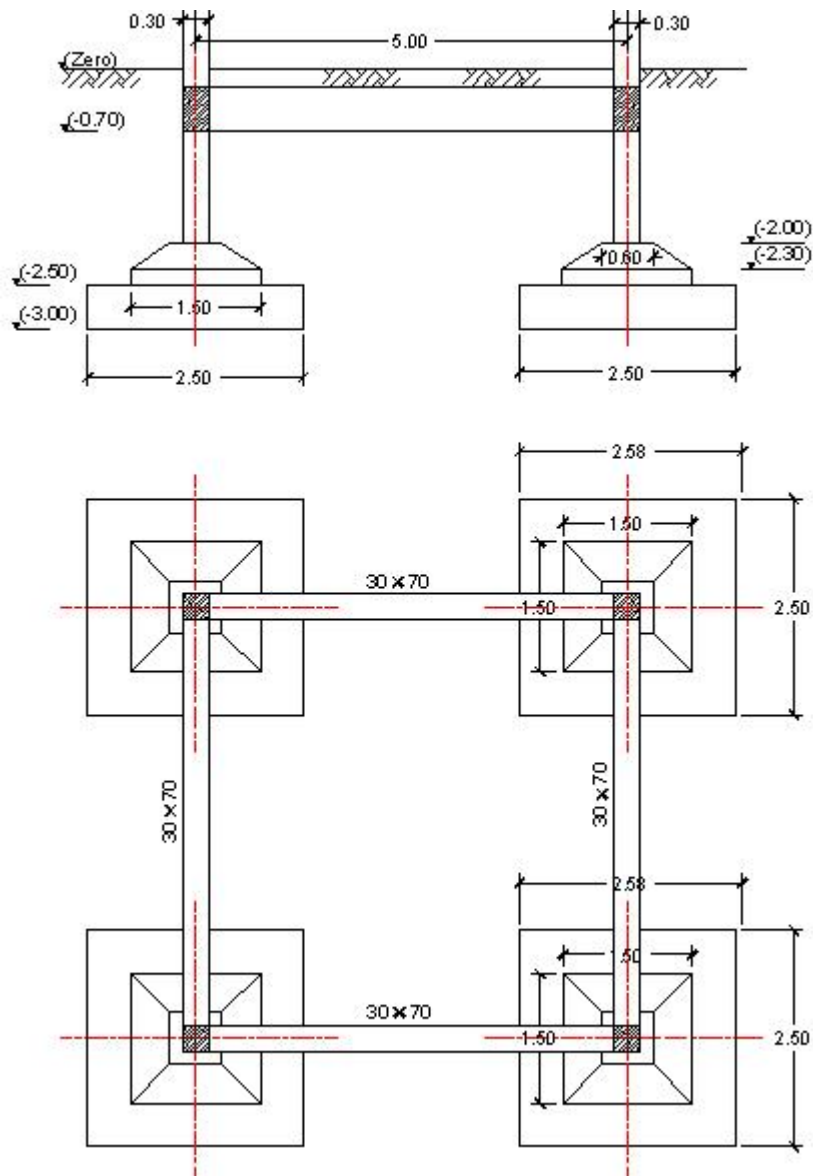

3. Perform quantity surveying for the different work items of the building shown below.

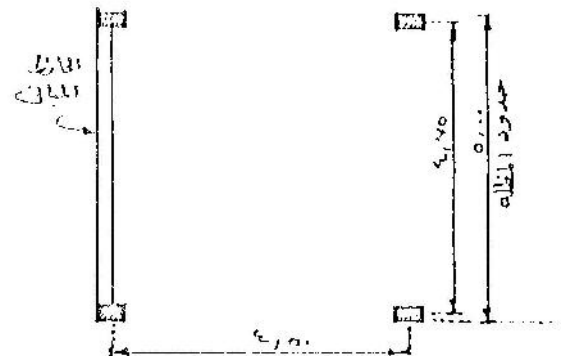
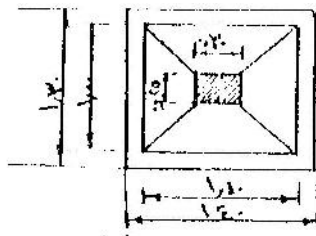
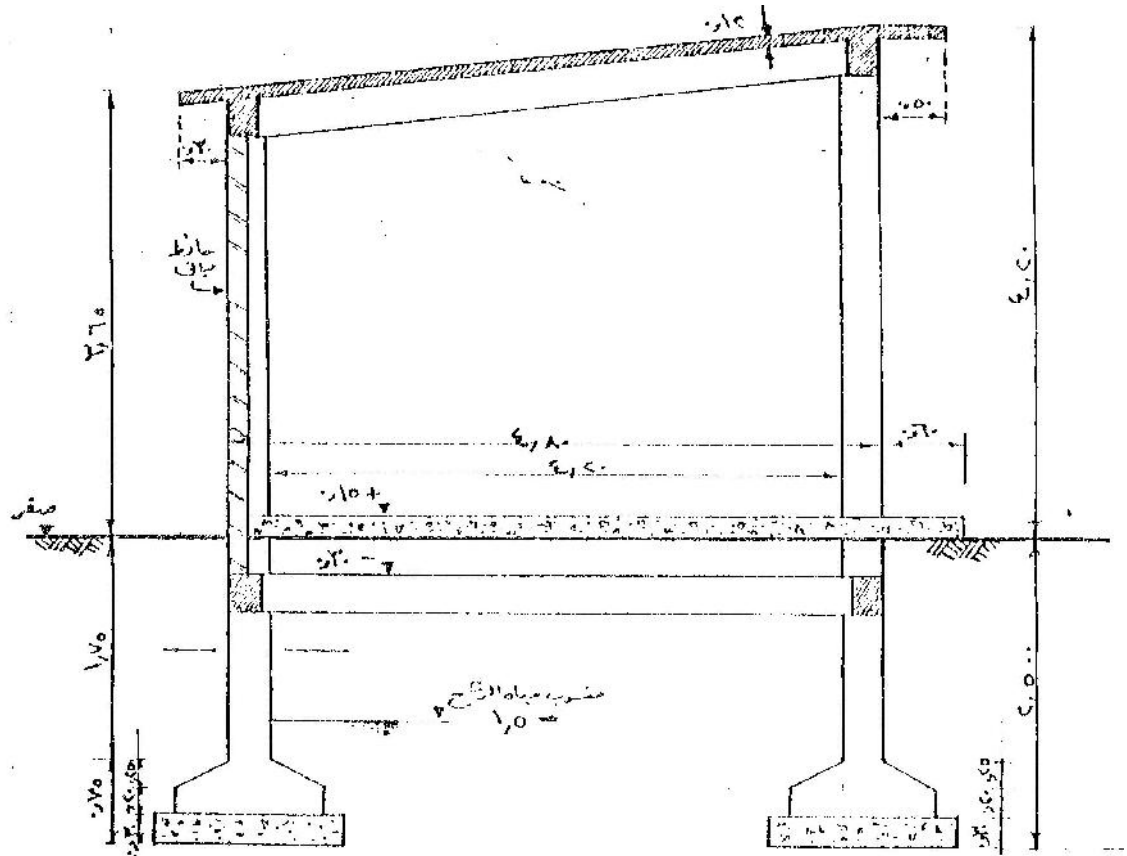

جميع كميات السقف بقطاع 4.0×2.0 متر
 جميع السجلات بقطاع 4.0×2.0 متر
 جميع قطعان التجهيز 2.0×2.0 متر
 العازل المباني حسب ما في الطبيعة
 حدود المظلة في الاتجاه الطولي والعرضي كما مبين بالترسم

مادة العزل

4. Consider the following figure; find the same requirements as above.

